



*sensing the*  
**FUTURE**

*InvenSense Developers Conference 2016*

InvenSense  
ICM-30670 SHV



# **SENSIRION**

**THE SENSOR COMPANY**

# Sensirion – The Sensor Company

---

Andreas Brauchli  
Software Engineer

IDC 2016, Santa Clara

# Facts & Figures

---

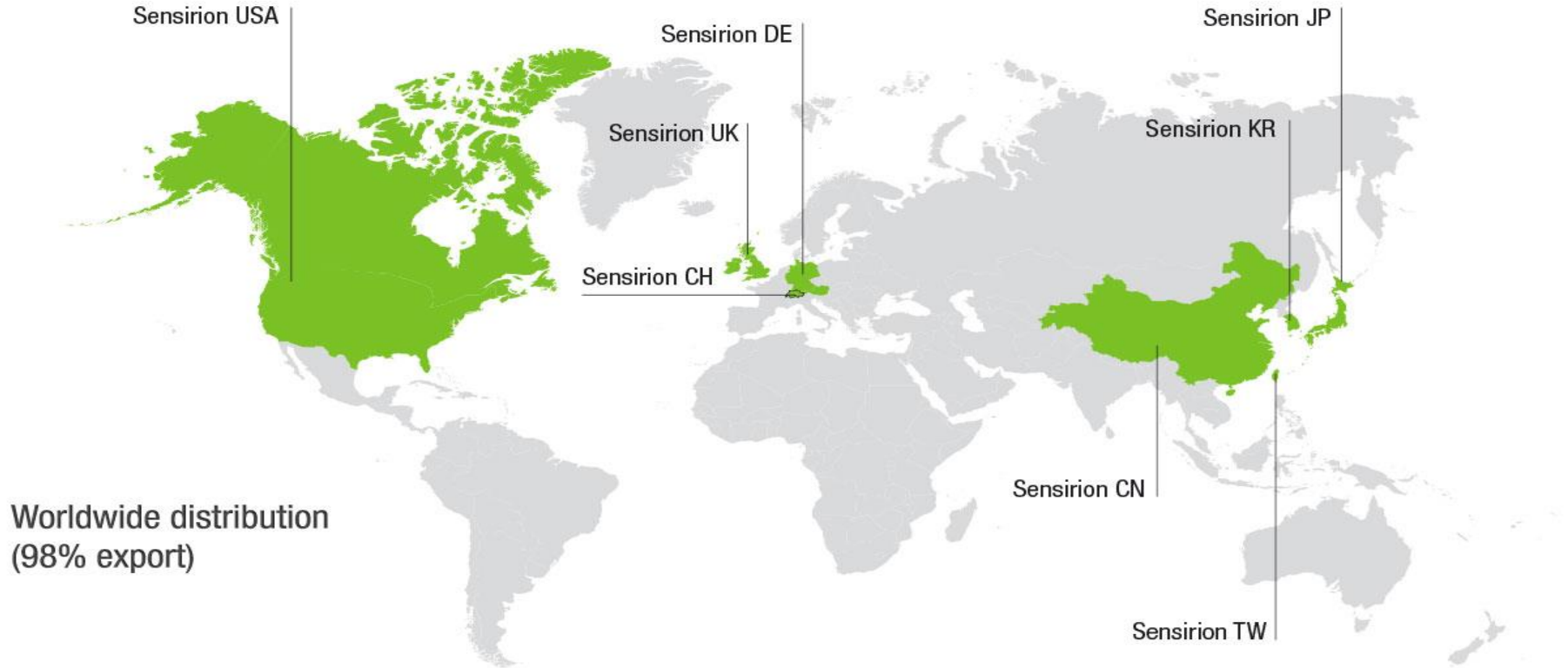

# Products

Humidity and temperature sensors



Liquid flow sensors



Differential pressure sensors



Mass flow meters for gases



Mass flow controllers for gases



Multi-Pixel gas sensors

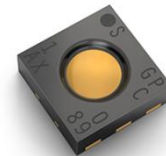

# Humidity & Temperature

---

Leading thanks to the world's smallest digital humidity sensors



## Automotive industry

Sensors for climate control in vehicles.



## Appliances

Sensors for energy regulation in refrigerators and dryers.



## Consumer electronics

Unlimited potential for the application of sensors in mobile devices.

# SENSIRION makes your product FEEL!

---

**We provide ambient sensing solutions.**

Countless successful applications in the field benefit from Sensirion's in-depth expertise and algorithms.



# SHT Integration

# SHT Sensor Solutions

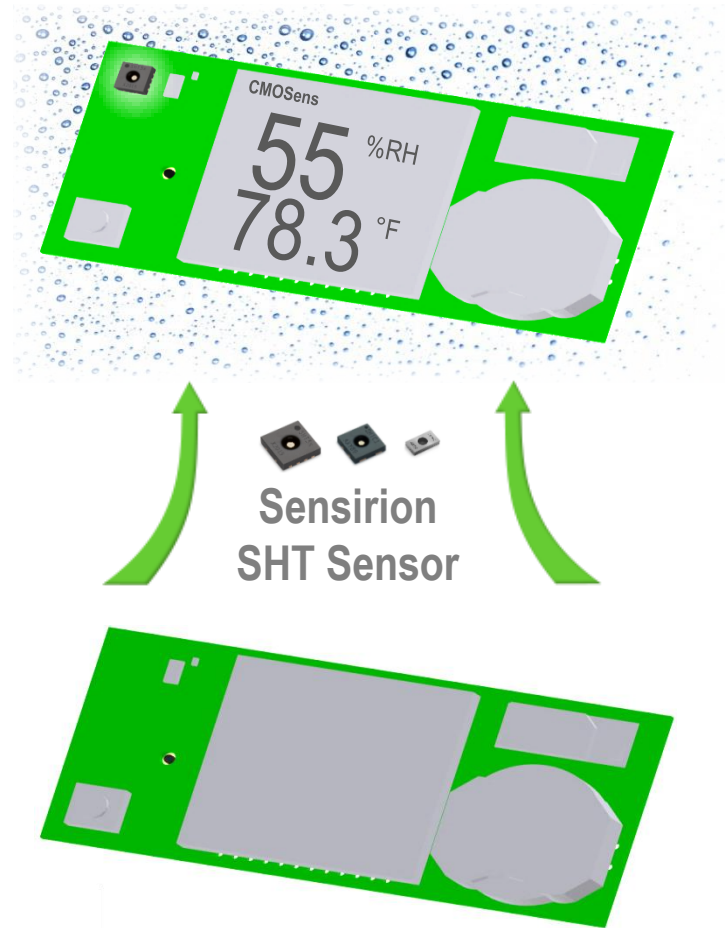

**We are experts in sensor integration.**  
Count on us for fast, smooth integration  
of your SHT sensor into any product.

Our application engineers love to make  
your new product feel humidity and  
temperature in the best possible way.





**The importance of a good integration.**

From experience we know how a good sensor integration makes *the* difference.

That's why we work closely together with our customers and achieve valuable yet low-cost SHT sensor solutions.

# SHT Integration

# SHT Sensor Solutions

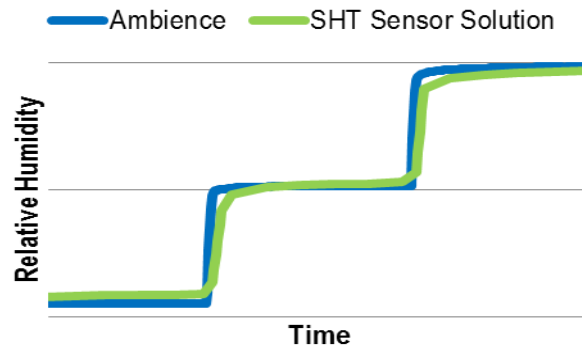
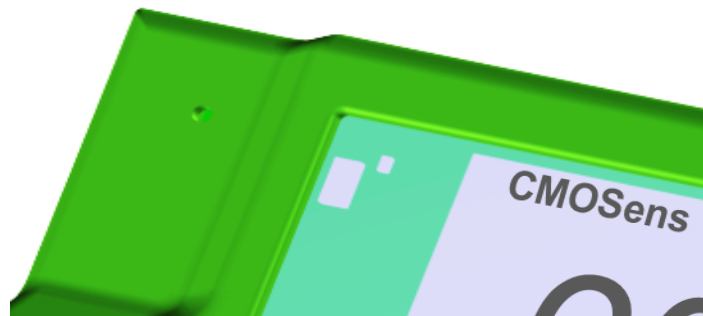

**The importance of a good integration.**

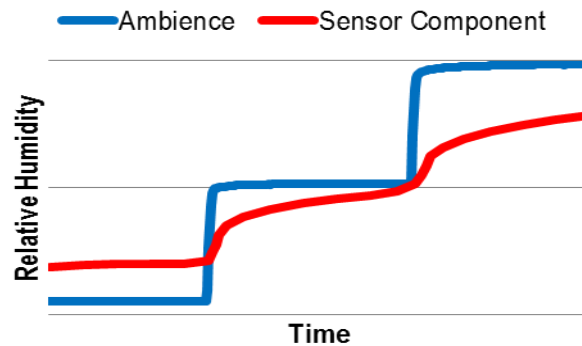

# SHT Compensation

## *SHT Sensor Solutions*

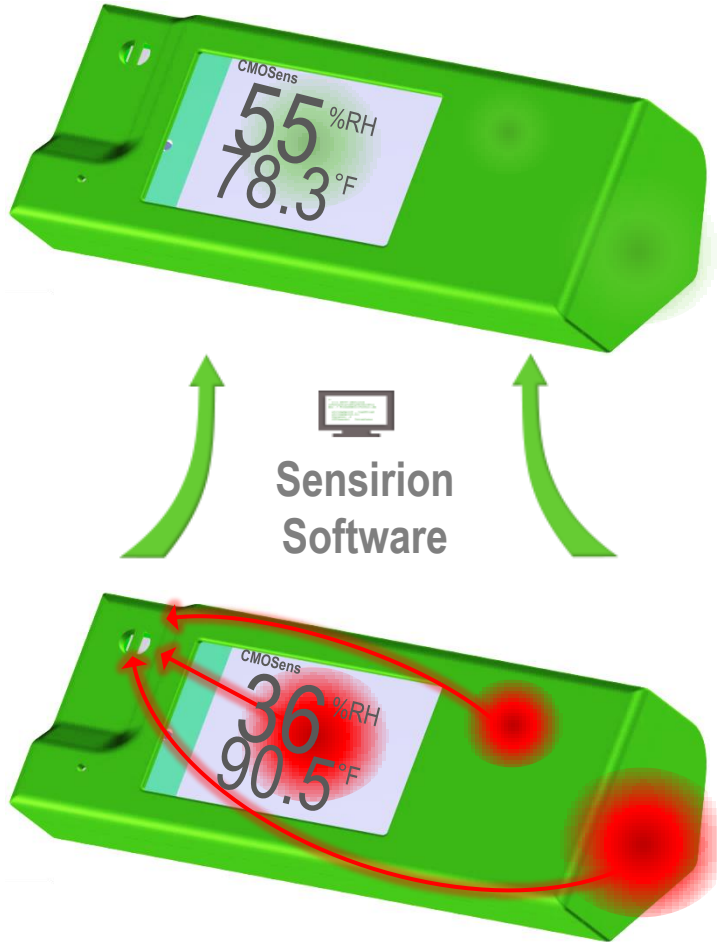

### **Accurate sensing with smart devices.**

Smart devices often produce heat, which results in offsets when sensing ambient temperature and humidity.

We provide easy-to-integrate software, that compensates all relevant heat effects of your new product.

# SHT Compensation

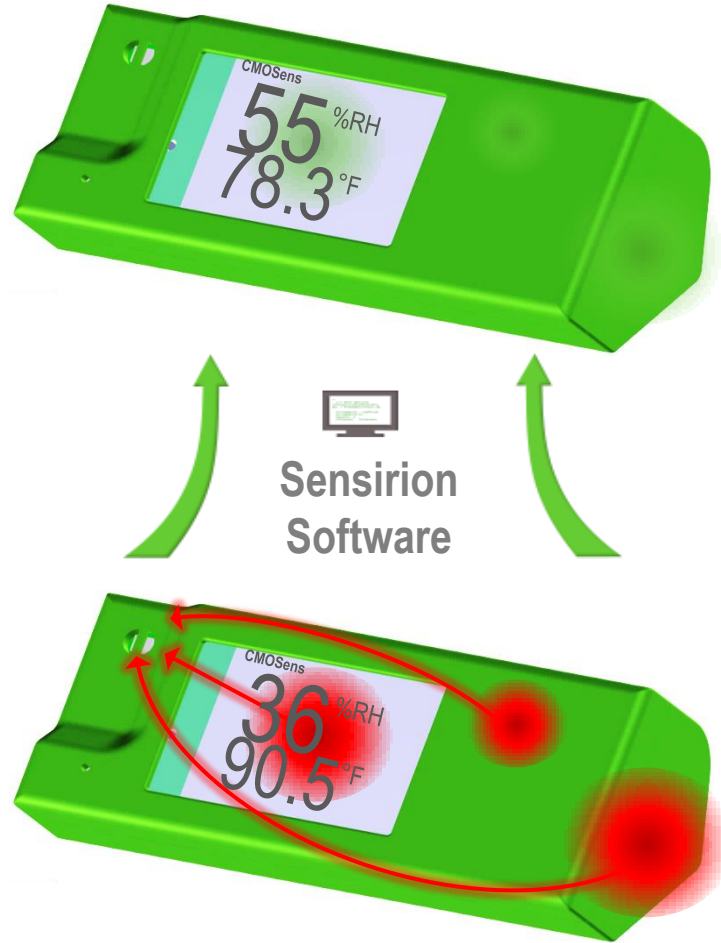

# SHT Sensor Solutions

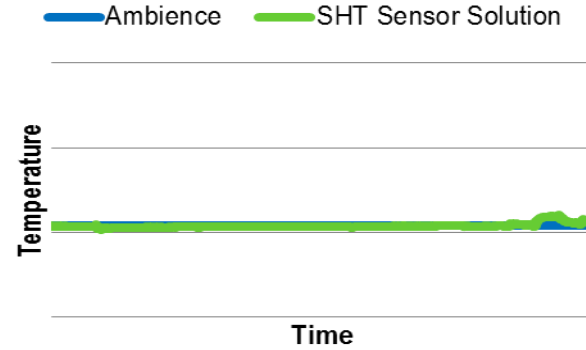

**Accurate sensing with smart devices.**

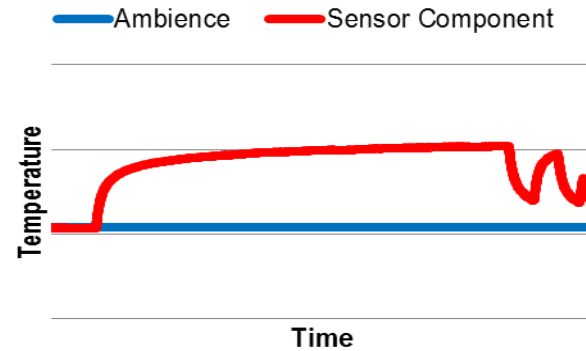

# Sensor Studio Integration

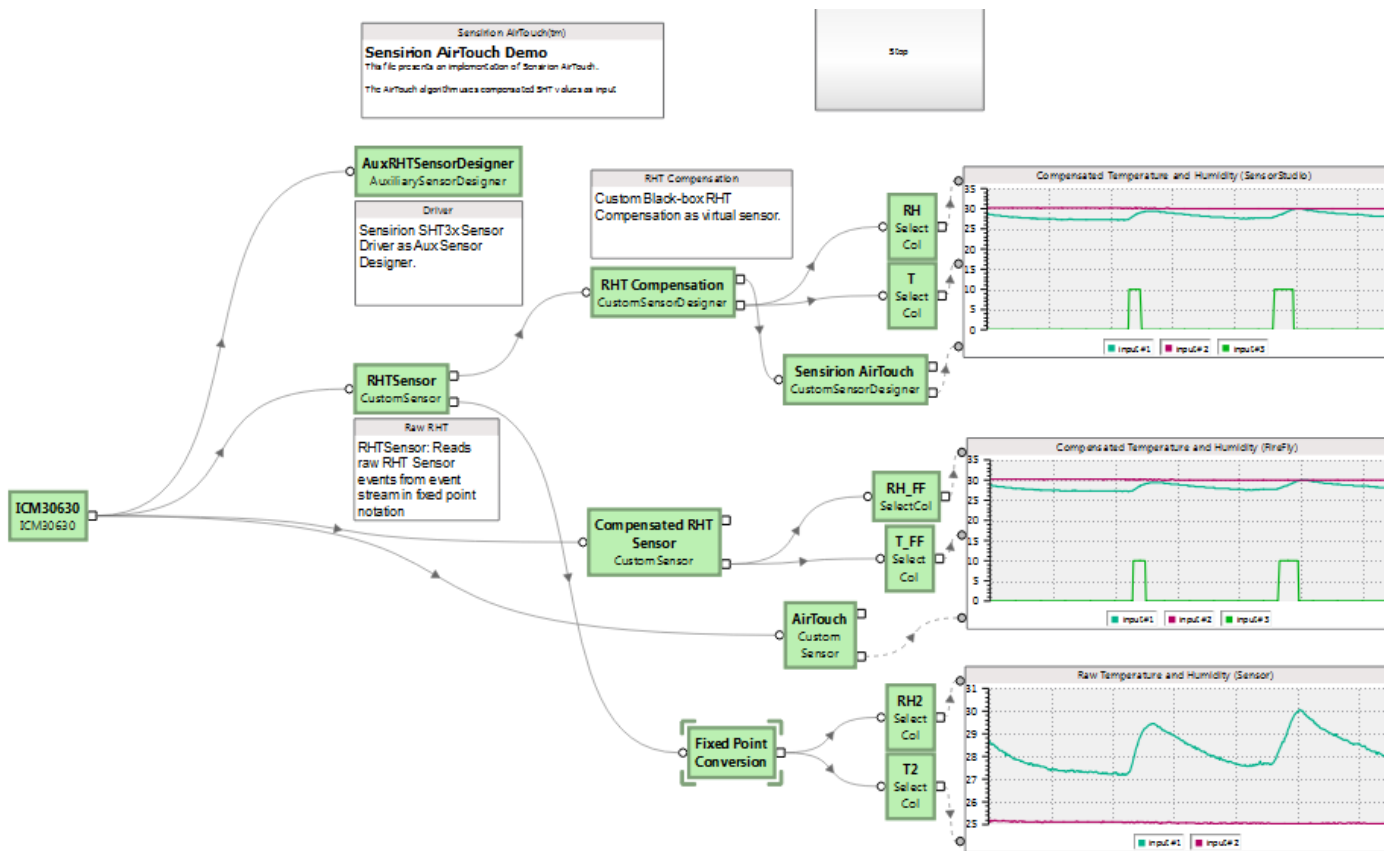

# Sensor Studio Integration

---

- Hardware Integration
- Driver Development and Testing
- SHT Compensation
- Application Development

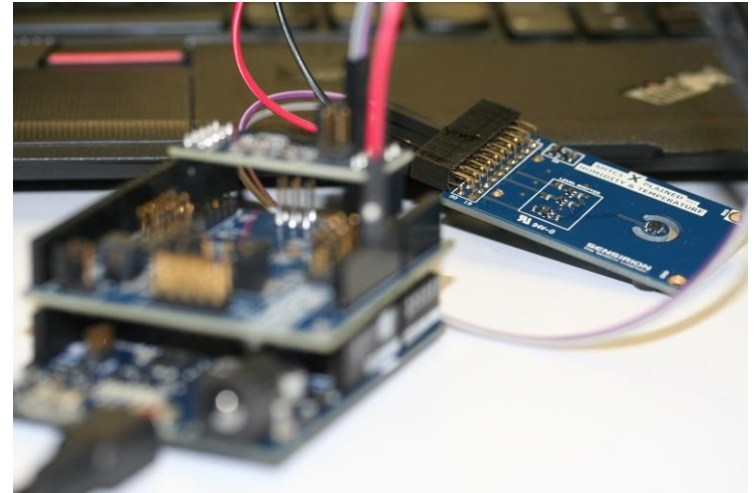

# Hardware Integration: Add Sensor to FireFly

---

- Consult FireFly hardware documentation
- Wire up

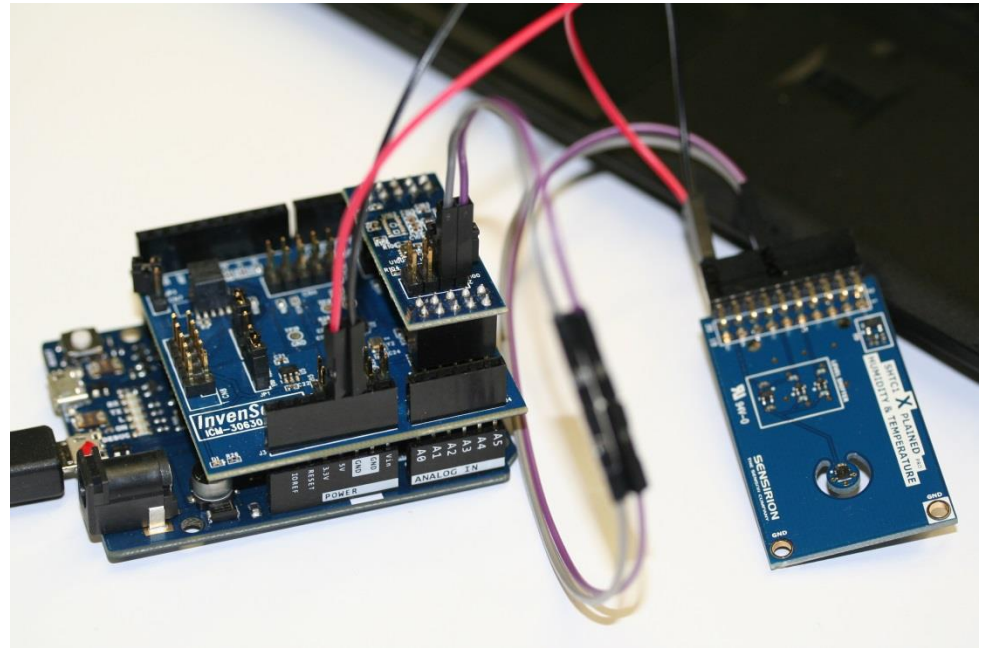

# Driver Development and Testing

- Generic driver adapted for FireFly
- Sensor output visualization

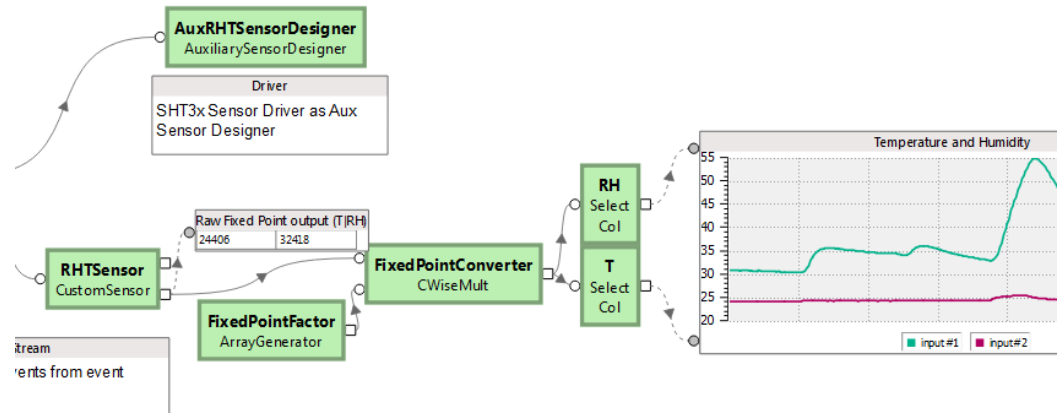



# SHT Compensation

- Chained and virtual sensor concept
- Source code integration

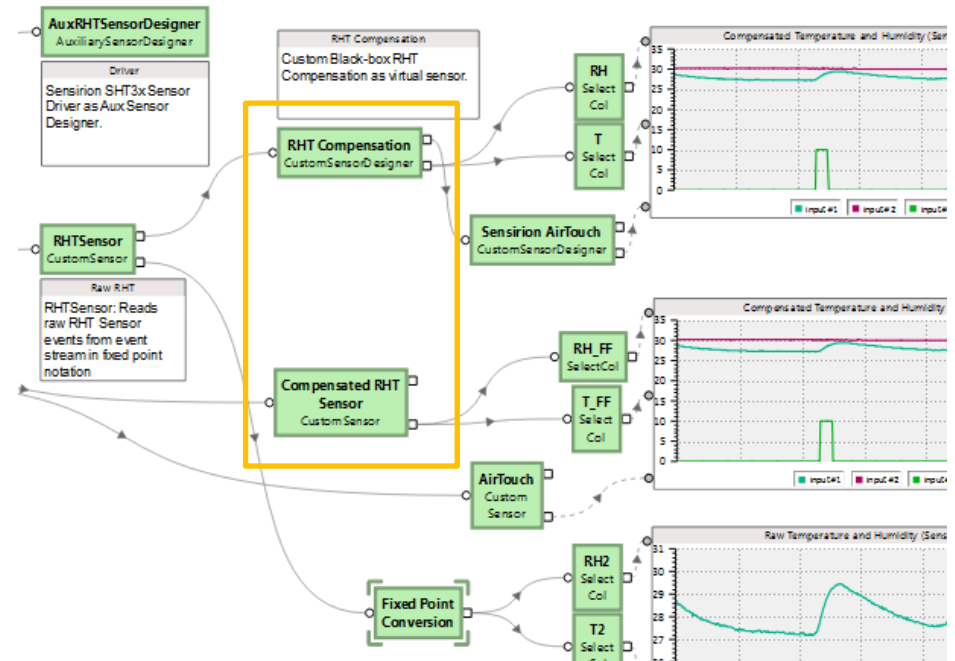

# Demo

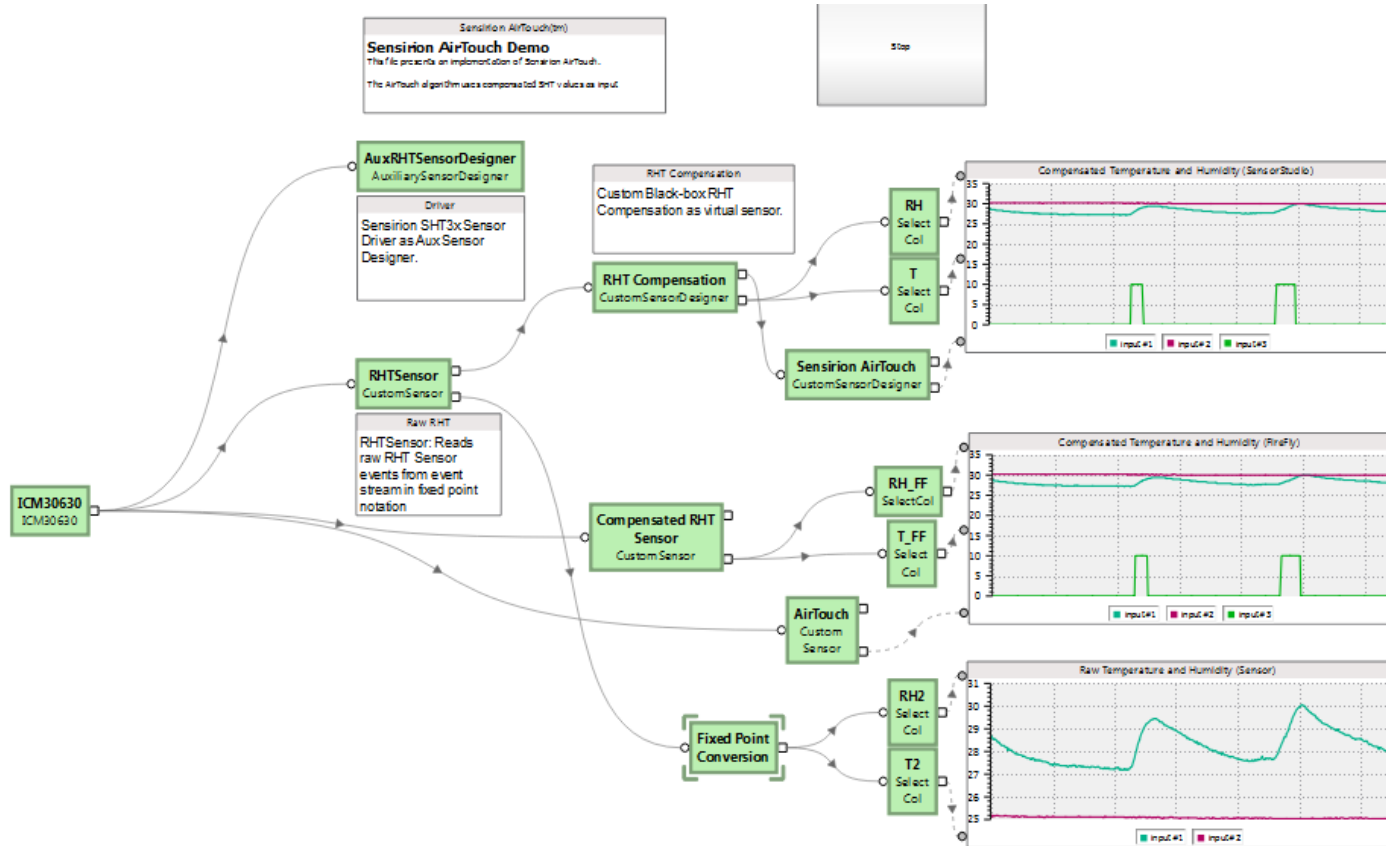

# Application Development

---

Weather station - Ambient temperature

Context change detection

On/Off body detection

AirTouch™

...

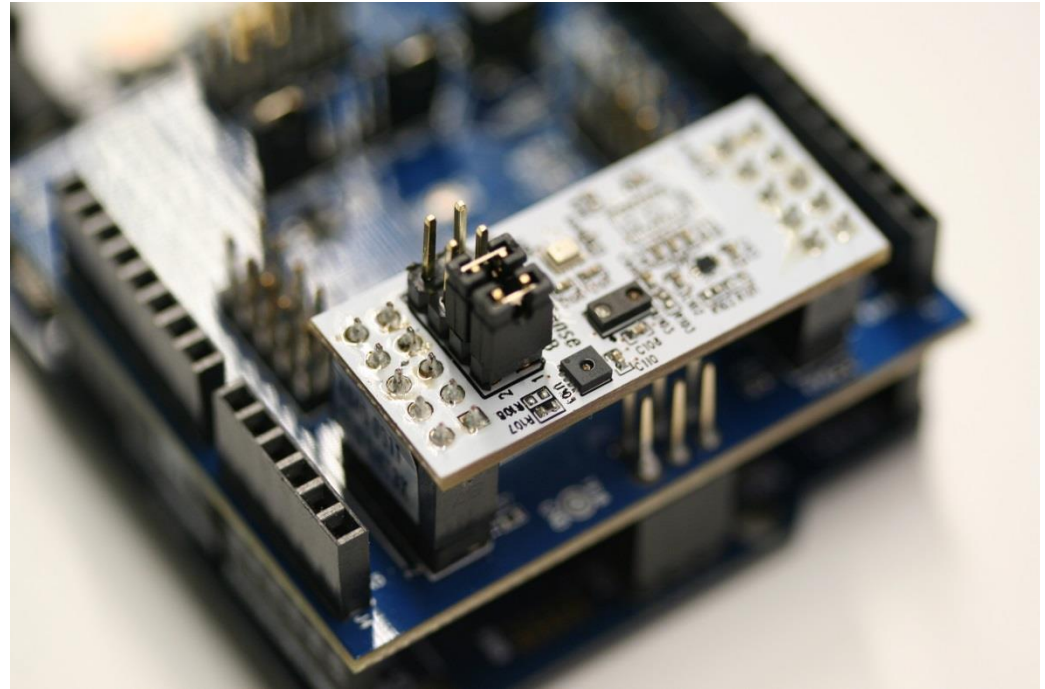

# Opportunities

---

## SensorStudio and our development process

- Software development
- Continuous integration
- Customer projects



# Thank you for your attention!

---

For more information, please visit our website on [www.sensirion.com](http://www.sensirion.com)



Thank You

